

TECHNICAL MANUAL
AND HANDLING GUIDE

MAXIMUS

TECHNICAL MANUAL
AND HANDLING GUIDE

INDEX

01	THE SYSTEM.....	04
02	PRODUCT TYPOLOGY, SIZES & PACKAGING DETAILS.....	06
03	TECHNICAL SPECIFICATIONS.....	10
04	SUGGESTED EQUIPMENT.....	16
05	HANDLING, CUT-TO-PIECES AND DRILLING.....	20
06	CUTTING INSTRUCTIONS.....	24
07	INSTALLATION (WALL, FLOOR AND FAÇADE).....	32
08	CLEANING AND MAINTENANCE.....	36



From the Largest to Every Detail. Maximus Redefines Surface Possibilities.

Maximus redefines contemporary surfaces with refined aesthetics inspired by marble, stone, concrete, and wood. Designed for versatility and durability, the collection offers seamless design possibilities and total flexibility, with solutions available in 5 thickness options for countertops, walls and floors.

PRODUCT SIZES

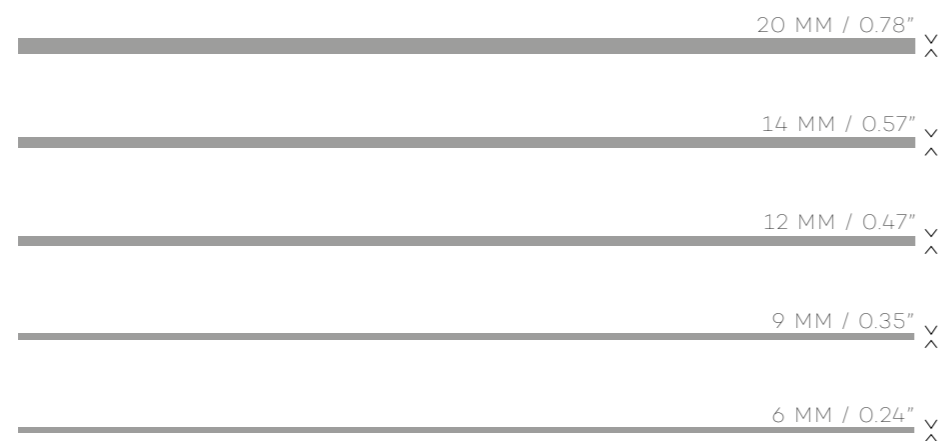
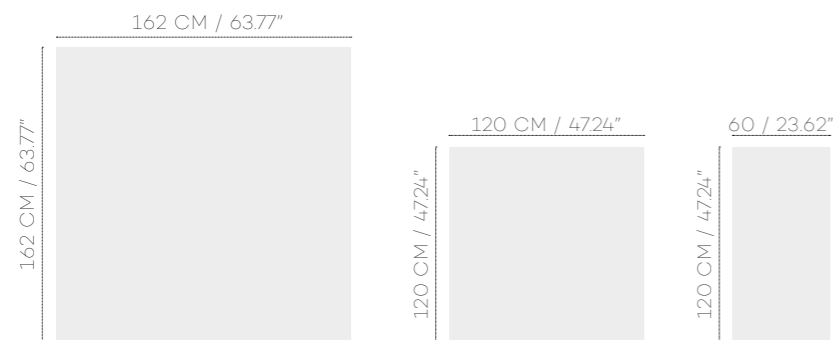
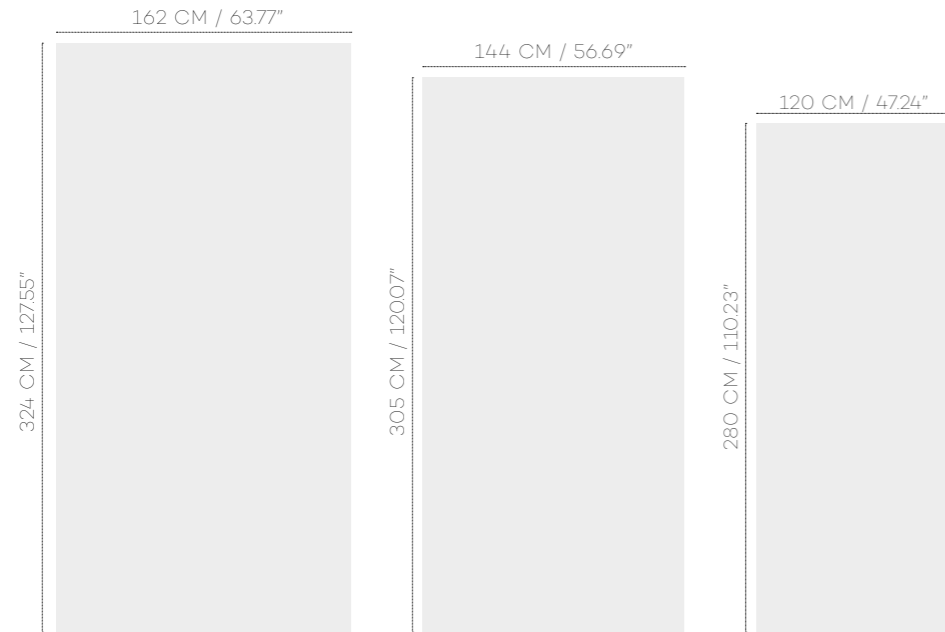

PRODUCT TYPOLOGY

BODY TYPE	SIZE (CM)	POLISHED	NATURAL	20 MM THICK	14 MM THICK	12 MM THICK	9 MM THICK	6 MM THICK
Porcelain Tiles	162X324	✓	✓			✓		
Porcelain Tiles	144X305	✓	✓		✓			
Full Body Porcelain Tiles	144x305	✓	✓		✓			
Porcelain Tiles	120X280	✓	✓				✓	✓
Porcelain Tiles	162X162	✓	✓				✓	
Porcelain Tiles	120X120	✓	✓				✓	
Porcelain Tiles	60X120	✓	✓	✓			✓	

PACKAGING DETAILS

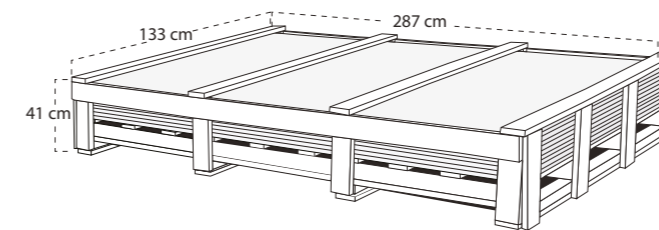

120x280 (9mm) PALLET DIMENSIONS (Horizontal)

PACKING MATERIAL	LENGTH (cm)	WIDTH (cm)	HEIGHT (cm)
WOODEN BOX	328	175	37

SIZE (cm)	THICKNESS (mm)	FINISH	TILE AREA (sqm)	KG per pc	PCS per pallet	TILE AREA per pallet (sqm)	WEIGHT per pallet (kg)
120x280	9	Matt / Polished	3.36	70.8	20	67.2	1545

SIZE (cm)	THICKNESS (mm)	PIECES x	M ² x	KG x	x Eu. Pallet	M ² x Eu. Pallet	kg x Eu. Pallet
120X120	9	2	2.88	62	30	86.40	1885
60X120	9	3	2.16	42	22	47.52	1011
60x120	9	2	1.44	28	30	43.2	921
60X120	20	1	0.72	30.5	30	21.60	939

Note: 162x162 cm packaging details available upon request

PACKAGING DETAILS

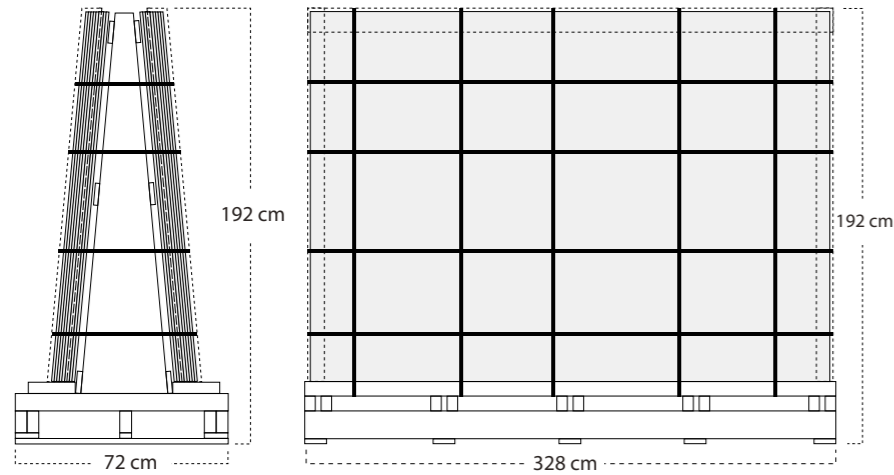

162x324 PALLET DIMENSIONS (A Frame Vertical)

PACKING MATERIAL	LENGTH (cm)	WIDTH (cm)	HEIGHT (cm)	Price
WOODEN BOX A-FRAME	328	75	192	200 USD

SIZE (cm)	THICKNESS (mm)	FINISH	TILE AREA (sqm)	KG per pc	PCS per pallet	TILE AREA per pallet (sqm)	WEIGHT per pallet (kg)
162x324	12	Matt / Polished	5.25	150	18	94.5	2850

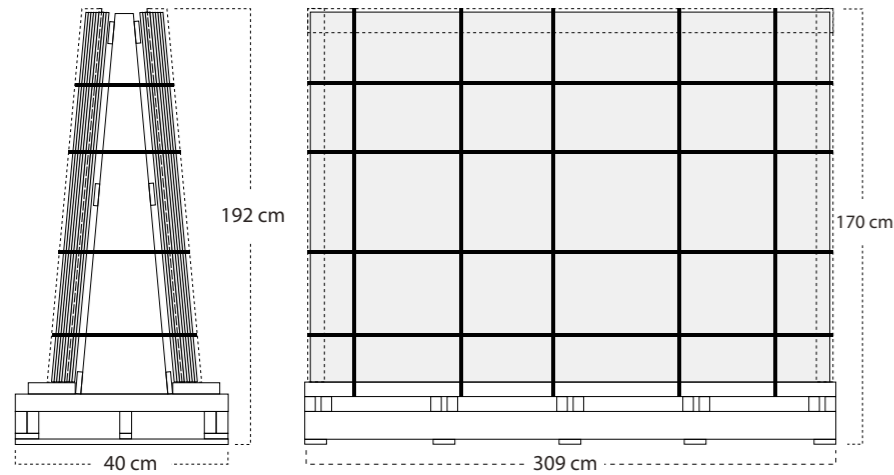

144x305 PALLET DIMENSIONS (A Frame Vertical)

PACKING MATERIAL	LENGTH (cm)	WIDTH (cm)	HEIGHT (cm)	Price
WOODEN BOX A-FRAME	309	40	170	200 USD

SIZE (cm)	THICKNESS (mm)	FINISH	TILE AREA (sqm)	KG per pc	PCS per pallet	TILE AREA per pallet (sqm)	WEIGHT per pallet (kg)
144x305	14	Matt / Polished	4.39	142	10	43.9	1570

Note: All weights and thickness mentioned in the above table are approximate average.

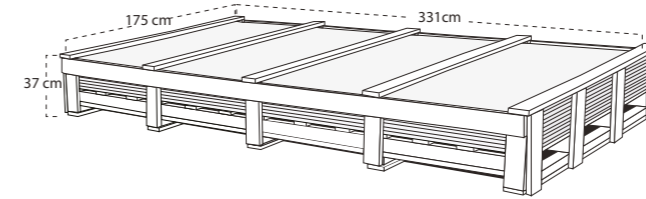

162x324 PALLET DIMENSIONS (Horizontal)

PACKING MATERIAL	LENGTH (cm)	WIDTH (cm)	HEIGHT (cm)
WOODEN BOX	328	175	37

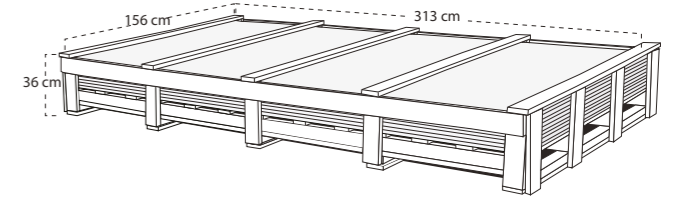

144x305 PALLET DIMENSIONS (Horizontal)

PACKING MATERIAL	LENGTH (cm)	WIDTH (cm)	HEIGHT (cm)
WOODEN BOX	313	156	36

SIZE (cm)	THICKNESS (mm)	FINISH	TILE AREA (sqm)	KG per pc	PCS per pallet	TILE AREA per pallet (sqm)	WEIGHT per pallet (kg)
162x324	12	Matt / Polished	5.25	150	15	78.75	2390
144x305	14	Matt / Polished	4.39	142	10	43.9	1535

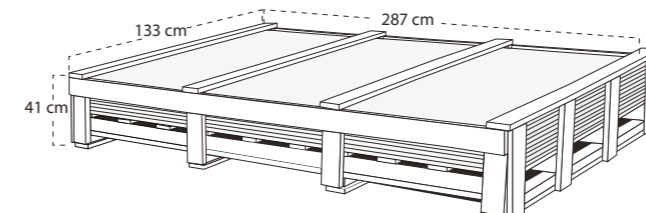

120x280 (9mm) PALLET DIMENSIONS (Horizontal)

PACKING MATERIAL	LENGTH (cm)	WIDTH (cm)	HEIGHT (cm)
WOODEN BOX	328	175	37

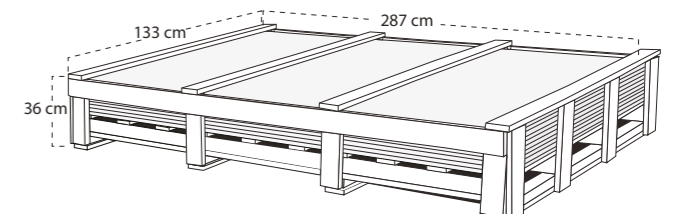

120x280 (6mm) PALLET DIMENSIONS (Horizontal)

PACKING MATERIAL	LENGTH (cm)	WIDTH (cm)	HEIGHT (cm)
WOODEN BOX	313	156	36

SIZE (cm)	THICKNESS (mm)	FINISH	TILE AREA (sqm)	KG per pc	PCS per pallet	TILE AREA per pallet (sqm)	WEIGHT per pallet (kg)
120x280	9	Matt / Polished	3.36	70.8	20	67.2	1545
120x280	6	Matt / Polished	3.36	50	20	67.2	1100



162x324 cm (12 mm) Porcelain Tiles (Bla - GL)

TEST DESCRIPTION	STANDARD TEST METHOD	STANDARD REQUIREMENTS	MAXIMUS SPECIFICATION	
			Porcelain Tiles (12 MM) 162x324 CM	
 Surface Quality	BS EN ISO 10545-2	A minimum of 95% of the tiles are to be free from visible defects	Minimum of 95% of the tiles are free from visible defects	
 Length & Width	BS EN ISO 10545-2	± 1.0mm	± 1.0mm	
 Thickness	BS EN ISO 10545-2	± 0.5mm	± 0.5mm	
 Straightness Of Sides	BS EN ISO 10545-2	± 0.8mm	± 0.8mm	
 Rectangularity	BS EN ISO 10545-2	± 1.5mm	± 1.2mm	
 Surface Flatness: Centre Curvature	BS EN ISO 10545-2	± 1.8mm	± 1.8mm	
 Surface Flatness: Edge Curvature	BS EN ISO 10545-2	± 1.8mm	± 1.5mm	
 Surface Flatness: Warpage	BS EN ISO 10545-2	± 1.8mm	± 1.5mm	
 Water Absorption	BS EN ISO 10545-3	≤ 0.5%	≤ 0.4%	
 Breaking Strength*	BS EN ISO 10545-4	≥ 1300 N	≥ 2000 N	
 Modulus Of Rupture*	BS EN ISO 10545-4	≥ 35 N/mm ²	≥ 40 N/mm ²	
 Coefficient Of Linear Thermal Expansion	BS EN ISO 10545-8	Test method available	≤ 7 X 10 ⁻⁶ /°C	
 Resistance To Thermal Shock	BS EN ISO 10545-9	Test method available	No visible defect	
 Crazing Resistance	BS EN ISO 10545-11	Required	No crazing	
 Frost Resistance	BS EN ISO 10545-12	Required	No visible damage	
 Resistance To Household Chemicals & Swimming Pool Salts	BS EN ISO 10545-13	Minimum Class B	Class A No visible effect	
 Resistance To Low Concentrations Acids & Alkalis	BE EN ISO 10545-13	Manufacturer to state classification	Min. Class LB (Matt) Class A (Polishes) No visible effect	
 Resistance To Staining (Natural)	BS EN ISO 10545-14	Minimum Class 3 (glazed) Test method available (Unglazed)	Min. Class 4 Stains removed	
 Resistance To Staining (Polished)	BS EN ISO 10545-14	Minimum Class 3 (glazed) Test method available (Unglazed)	Min. Class 3 Stains removed	

Note: This technical specifications are applicable only to tiles in choice "A".

* Test performed using 60x120 cm cut pieces from the slab.
* Thickness is nominal

144x305 cm (14 mm) Porcelain Tiles (Bla - GL) and Full Body Porcelain Tiles (Bla - UGL)

TEST DESCRIPTION	STANDARD TEST METHOD	STANDARD REQUIREMENTS	MAXIMUS SPECIFICATION	
			Porcelain Tiles (14 MM) 144x305 CM	Full Body Porcelain Tiles (14 MM) 144x305 CM
 Surface Quality	BS EN ISO 10545-2	A minimum of 95% of the tiles are to be free from visible defects	Minimum of 95% of the tiles are free from visible defects	
 Length & Width	BS EN ISO 10545-2	± 1.0mm	± 1.0mm	± 1.0mm
 Thickness	BS EN ISO 10545-2	± 0.5mm	± 0.5mm	± 0.5mm
 Straightness Of Sides	BS EN ISO 10545-2	± 0.8mm	± 0.8mm	± 0.8mm
 Rectangularity	BS EN ISO 10545-2	± 1.5mm	± 1.2mm	± 1.2mm
 Surface Flatness: Centre Curvature	BS EN ISO 10545-2	± 1.8mm	± 1.8mm	± 1.8mm
 Surface Flatness: Edge Curvature	BS EN ISO 10545-2	± 1.8mm	± 1.5mm	± 1.5mm
 Surface Flatness: Warpage	BS EN ISO 10545-2	± 1.8mm	± 1.5mm	± 1.5mm
 Water Absorption	BS EN ISO 10545-3	≤ 0.5%	≤ 0.4%	≤ 0.1%
 Breaking Strength*	BS EN ISO 10545-4	≥ 1300 N	≥ 3500 N	≥ 3500 N
 Modulus Of Rupture*	BS EN ISO 10545-4	≥ 35 N/mm ²	≥ 40 N/mm ²	≥ 40 N/mm ²
 Resistance To Deep Abrasion	BS EN ISO 10545-6	≤ 175 mm ³	-	≤ 150 mm ³
 Coefficient Of Linear Thermal Expansion	BS EN ISO 10545-8	Test method available	≤ 7 X 10 ⁻⁶ /°C	≤ 7 X 10 ⁻⁶ /°C
 Resistance To Thermal Shock	BS EN ISO 10545-9	Test method available	No visible defect	No visible defect
 Frost Resistance	BS EN ISO 10545-12	Required	No visible damage	No visible damage
 Resistance To Household Chemicals & Swimming Pool Salts	BS EN ISO 10545-13	Minimum B	Class A No visible effect	Class A No visible effect
 Resistance To Low Concentrations Acids & Alkalis	BE EN ISO 10545-13	Manufacturer to state classification	Class LA No visible effect	Class LA No visible effect
 Resistance To High Concentrations Acids & Alkalis	BS EN ISO 10545-13	Test method available	Class HA No visible effect	Class HA No visible effect
 Resistance To Staining (Natural)	BS EN ISO 10545-14	Min. Class 3	Min. Class 4 Stains removed	Min. Class 3 Stains removed
 Resistance To Staining (Polished)	BS EN ISO 10545-14	Min. Class 3	Min. Class 3 Stains removed	Min. Class 2 Stains removed

Note: This technical specifications are applicable only to tiles in choice "A".

* Test performed using 60x120 cm cut pieces from the slab.
* Thickness is nominal

120x280 cm (6 mm) Porcelain Tiles (Bla - GL)

TEST DESCRIPTION	STANDARD TEST METHOD	STANDARD REQUIREMENTS	MAXIMUS SPECIFICATION
			Porcelain Tile (6 MM) 120x280 CM
 Surface Quality	BS EN ISO 10545-2	A minimum of 95% of the tiles are to be free from visible defects	Minimum of 95% of the tiles are free from visible defects
 Length & Width	BS EN ISO 10545-2	± 1.0mm	± 1.0mm
 Thickness	BS EN ISO 10545-2	± 0.5mm	± 0.5mm
 Straightness Of Sides	BS EN ISO 10545-2	± 0.8mm	± 0.8mm
 Rectangularity	BS EN ISO 10545-2	± 1.5mm	± 1.2mm
 Surface Flatness: Centre Curvature	BS EN ISO 10545-2	± 1.8mm	± 1.8mm
 Surface Flatness: Edge Curvature	BS EN ISO 10545-2	± 1.8mm	± 1.5mm
 Surface Flatness: Warpage	BS EN ISO 10545-2	± 1.8mm	± 1.5mm
 Water Absorption	BS EN ISO 10545-3	≤ 0.5%	≤ 0.4%
 Breaking Strength*	BS EN ISO 10545-4	≥ 700 N	≥ 700 N
 Modulus Of Rupture*	BS EN ISO 10545-4	≥ 35 N/mm ²	≥ 35 N/mm ²
 Coefficient Of Linear Thermal Expansion	BS EN ISO 10545-8	Test method available	≤ 7 X 10 ⁻⁶ /°C
 Resistance To Thermal Shock	BS EN ISO 10545-9	Test method available	No visible defect
 Frost Resistance	BS EN ISO 10545-12	Required	No visible damage
 Resistance To Household Chemicals & Swimming Pool Salts	BS EN ISO 10545-13	Minimum B	Class A No visible effect
 Resistance To Low Concentrations Acids & Alkalis	BE EN ISO 10545-13	Manufacturer to state classification	Class LA No visible effect
 Resistance To High Concentrations Acids & Alkalis	BS EN ISO 10545-13	Test method available	Class HA No visible effect
 Resistance To Staining (Natural)	BS EN ISO 10545-14	Min. Class 3	Min. Class 4 Stains removed
 Resistance To Staining (Polished)	BS EN ISO 10545-14	Min. Class 3	Min. Class 3 Stains removed

Note: This technical specifications are applicable only to tiles in choice "A".

* Test performed using 60x120 cm cut pieces from the slab.
* Thickness is nominal





120x280 cm (9mm) Porcelain Tiles (Bla - GL)

TEST DESCRIPTION	STANDARD TEST METHOD	STANDARD REQUIREMENTS	MAXIMUS SPECIFICATION
			Porcelain Tile (9 MM) 120x280 CM
 Surface Quality	BS EN ISO 10545-2	A minimum of 95% of the tiles are to be free from visible defects	Minimum of 95% of the tiles are free from visible defects
 Length & Width	BS EN ISO 10545-2	± 1.0mm	± 1.0mm
 Thickness	BS EN ISO 10545-2	± 0.5mm	± 0.4mm
 Straightness Of Sides	BS EN ISO 10545-2	± 0.8mm	± 0.8mm
 Rectangularity	BS EN ISO 10545-2	± 1.5mm	± 1.2mm
 Surface Flatness: Centre Curvature	BS EN ISO 10545-2	± 1.8mm	± 1.8mm
 Surface Flatness: Edge Curvature	BS EN ISO 10545-2	± 1.8mm	± 1.5mm
 Surface Flatness: Warpage	BS EN ISO 10545-2	± 1.8mm	± 1.5mm
 Water Absorption	BS EN ISO 10545-3	≤ 0.5%	≤ 0.4%
 Breaking Strength*	BS EN ISO 10545-4	≥ 1300 N	≥ 2000 N
 Modulus Of Rupture*	BS EN ISO 10545-4	≥ 35 N/mm ²	≥ 40 N/mm ²
 Coefficient Of Linear Thermal Expansion	BS EN ISO 10545-8	Test method available	≤ 7 X 10 ⁻⁶ /°C
 Resistance To Thermal Shock	BS EN ISO 10545-9	Test method available	No visible defect
 Frost Resistance	BS EN ISO 10545-12	Required	No visible damage
 Resistance To Household Chemicals & Swimming Pool Salts	BS EN ISO 10545-13	Minimum B	Class A No visible effect
 Resistance To Low Concentrations Acids & Alkalis	BE EN ISO 10545-13	Manufacturer to state classification	Class LA No visible effect
 Resistance To High Concentrations Acids & Alkalis	BS EN ISO 10545-13	Test method available	Class HA No visible effect
 Resistance To Staining (Natural)	BS EN ISO 10545-14	Min. Class 3	Min. Class 4 Stains removed
 Resistance To Staining (Polished)	BS EN ISO 10545-14	Min. Class 3	Min. Class 3 Stains removed

Note: This technical specifications are applicable only to tiles in choice "A".

* Test performed using 60x120 cm cut pieces from the slab.
* Thickness is nominal

162X162 cm (9 mm) Porcelain Tiles (Bla - GL)

TEST DESCRIPTION	STANDARD TEST METHOD	STANDARD REQUIREMENTS	MAXIMUS SPECIFICATION
			Porcelain Tile (9 MM) 162X162 CM
 Surface Quality	BS EN ISO 10545-2	A minimum of 95% of the tiles are to be free from visible defects	Minimum of 95% of the tiles are free from visible defects
 Length & Width	BS EN ISO 10545-2	± 1.0mm	± 1.0mm
 Thickness	BS EN ISO 10545-2	± 0.5mm	± 0.4mm
 Straightness Of Sides	BS EN ISO 10545-2	± 0.8mm	± 0.8mm
 Rectangularity	BS EN ISO 10545-2	± 1.5mm	± 1.2mm
 Surface Flatness: Centre Curvature	BS EN ISO 10545-2	± 1.8mm	± 1.8mm
 Surface Flatness: Edge Curvature	BS EN ISO 10545-2	± 1.8mm	± 1.5mm
 Surface Flatness: Warpage	BS EN ISO 10545-2	± 1.8mm	± 1.5mm
 Water Absorption	BS EN ISO 10545-3	≤ 0.5%	≤ 0.4%
 Breaking Strength*	BS EN ISO 10545-4	≥ 1300 N	≥ 2000 N
 Modulus Of Rupture*	BS EN ISO 10545-4	≥ 35 N/mm ²	≥ 40 N/mm ²
 Coefficient Of Linear Thermal Expansion	BS EN ISO 10545-8	Test method available	≤ 7 X 10 ⁻⁶ /°C
 Resistance To Thermal Shock	BS EN ISO 10545-9	Test method available	No visible defect
 Frost Resistance	BS EN ISO 10545-12	Required	No visible damage
 Resistance To Household Chemicals & Swimming Pool Salts	BS EN ISO 10545-13	Minimum B	Class A No visible effect
 Resistance To Low Concentrations Acids & Alkalis	BE EN ISO 10545-13	Manufacturer to state classification	Class LA No visible effect
 Resistance To High Concentrations Acids & Alkalis	BS EN ISO 10545-13	Test method available	Class HA No visible effect
 Resistance To Staining (Natural)	BS EN ISO 10545-14	Min. Class 3	Min. Class 4 Stains removed
 Resistance To Staining (Polished)	BS EN ISO 10545-14	Min. Class 3	Min. Class 3 Stains removed

Note: This technical specifications are applicable only to tiles in choice "A".

* Test performed using 60x120 cm cut pieces from the slab.
* Thickness is nominal











120x120 cm (9 mm) and 60x120cm (9 mm & 20 mm) Porcelain Tiles (Bla - GL)

TEST DESCRIPTION	STANDARD TEST METHOD	STANDARD REQUIREMENTS	MAXIMUS SPECIFICATION	
			Porcelain Tiles (9 MM) 120x120 and 60x120	Porcelain Tiles (20 MM) 60x120
 Surface Quality	BS EN ISO 10545-2	a minimum of 95% of the tiles are to be free from visible defects	Minimum of 95% of the tiles are free from visible defects	
 Length & Width	BS EN ISO 10545-2	± 1.0mm	± 1.0mm	± 1.0mm
 Thickness	BS EN ISO 10545-2	± 0.5mm	± 0.4mm	± 0.5mm
 Straightness Of Sides	BS EN ISO 10545-2	± 0.8mm	± 0.8mm	± 0.8mm
 Rectangularity	BS EN ISO 10545-2	± 1.5mm	± 1.2mm	± 1.2mm
 Surface Flatness: Centre Curvature	BS EN ISO 10545-2	± 1.8mm	± 1.8mm	± 1.8mm
 Surface Flatness: Edge Curvature	BS EN ISO 10545-2	± 1.8mm	± 1.8mm	± 1.8mm
 Surface Flatness: Warpage	BS EN ISO 10545-2	± 1.8mm	± 1.5mm	± 1.5mm
 Water Absorption	BS EN ISO 10545-3	≤ 0.5%	≤ 0.4%	≤ 0.4%
 Breaking Strength*	BS EN ISO 10545-4	≥ 1300 N	≥ 2000 N	≥ 10000 N
 Modulus Of Rupture*	BS EN ISO 10545-4	≥ 35 N/mm ²	≥ 40 N/mm ²	≥ 40 N/mm ²
 Coefficient Of Linear Thermal Expansion	BS EN ISO 10545-8	Test method available	≤ 7 X 10 ⁻⁶ /°C	≤ 7 X 10 ⁻⁶ /°C
 Resistance To Thermal Shock	BS EN ISO 10545-9	Test method available	No visible defect	No visible defect
 Crazing Resistance	BS EN ISO 10545-11	Required	No crazing	No crazing
 Frost Resistance	BS EN ISO 10545-12	Required	No visible damage	No visible damage
 Resistance To Household Chemicals & Swimming Pool Salts	BS EN ISO 10545-13	Minimum B	Class A No visible effect	Class A No visible effect
 Resistance To Low Concentrations Acids & Alkalis	BE EN ISO 10545-13	Manufacturer to state classification	Class LA No visible effect	Class LA No visible effect
 Resistance To Staining	BS EN ISO 10545-14	Min. Class 3	Min. Class 4 Stains removed	Min. Class 4 Stains removed











Note: This technical specifications are applicable only to tiles in choice "A".

* Test performed using 60x120 cm cut pieces from the slab.
* Thickness is nominal

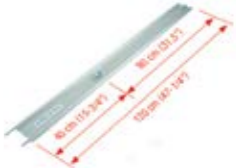
HANDLING EQUIPMENT

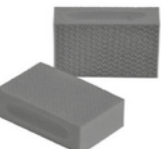
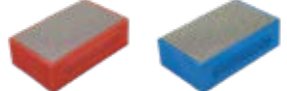
ITEM NUMBER	OPTION 1	OPTION 2
ITEM 1	 <p>Aluminum Parallel profile with crossbars and Suction Vacuum suction cups with vacuum gauge</p>	 <p>Super Lift for handling large Tiles with suction cups with Double safety Gauge</p>
ITEM 2	 <p>Tile Cart Trolley</p>	 <p>Multi purpose Bogie for transporting & Machinnings Slab</p>
ITEM 3	 <p>Double Suction Cups</p>	 <p>Double Suction Cup to move and align slabs.</p>
ITEM 4	 <p>Modular Work Bench BM180</p>	 <p>Work Table with 3 way extension (Height, Length & Width)</p>
ITEM 5	 <p>Modular Work Bench BM180 BM180 Plus (Perfect Workstation for tiles up to 160cm width)</p>	 <p>Table One - Work Table for Tiles up to 480 cm in length.</p>

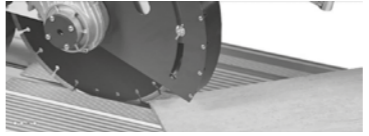



CUTTING AND DRILLING EQUIPMENT

ITEM NUMBER	OPTION 1	OPTION 2
ITEM 1	 <p>Compass device with suction cups for Circular Cuts</p>	 <p>Electric Suction Cup</p>
ITEM 2	 <p>Free cut guide with complete outfit Max. Cut of length – 156 cm</p>	 <p>Complete Manual Cutting System For Porcelain, Ceramic, Glass tiles & Slabs of up to 340 cm</p>
ITEM 3	 <p>Free Cut Extension</p>	 <p>Modular Bar</p>
ITEM 4	 <p>Cutting off pliers for tile/slabs</p>	 <p>Reinforcement DUAL Splitting System</p>
ITEM 5	 <p>Diamond polishing pad</p>	 <p>Diamond Hand Pads for Edge Cleaning</p>
ITEM 6	 <p>Diamond for edge and side polishing</p>	 <p>Diamond Polishing Pads for Polishing and Grinding.</p>
ITEM 7	 <p>Diamond Blades for simultaneous cutting and grooving</p>	 <p>Motorized Dry Cutting System for Tiles of 3mtr Plus. Can cut up to 4cm thick Tiles.</p>

INSTALLATION AND LEVELLING EQUIPMENT

ITEM NUMBER	OPTION 1	OPTION 2
ITEM 1	 Compact Vibrator or Tile Beater	 Thumping Suction Cup for Tiles - Vibrator with 3 Speed
ITEM 2	 RLS 3D Clips for tiles	 LS Compact Clip & Wedges
ITEM 3	 Wedges (for Anti-Chipping / Anti-Scratching preventing platforms)	 Wedge Base- Ideal to use Levelling system from 3 to 5mm Thickness Tiles
ITEM 4	 Adjustable pliers for wall and floor covering	 Ergonomic Pliers
ITEM 5	 Low-speed mixer	 Electrical Hand Held Mixer
ITEM 6	 Rubber Grout floats	 Rubber trowel designed to get optimal grouting results
ITEM 7	 Slant ridge notched trowel	 Open Ended Notched Trowel of different Sizes

CLEANING AND MAINTENANCE

ITEM NUMBER	OPTION 1	OPTION 2
ITEM 1	 Brooms	 Cleaning Equipment
ITEM 2	 Floats with abrasive pads	 Grouting Float

Superior quality raw materials like kaolin, clay, feldspar, silica, and colouring inks are imported from Europe and other parts of the world to manufacture Maximus, without compromising on its breaking strength, water absorption, dust, termite and chemical resistance. Maximus tiles are exceptionally hard, resist thermal shock better than any material available today, are virtually non-porous and are a green product. Installation is quicker and easier because of the dimensions of the product. Flooring, wall cladding, kitchen counter tops, vanity tops, steps and risers, and bath surrounds are all possible.

HANDLING MAXIMUS

- Maximus arrives in oversized crates, which require specific Handling equipment to prevent from damage occurring during forklift operation, specific fork sizes must be used.
- To handle the same crate from the narrow end requires forks that are at least 213cm/ 84" long. Lifting multiple crates with longer forks may require forklifts with a greater lift capacity.
- Specialized tools and equipment are currently available for the handling, installation and cutting of large porcelain surfaces. Innovative trowels with unique notch configurations can help increase the consistency of the mortar coverage on the back of the tile.
- To increase rigidity and limit twisting, use a system composed of parallel and transverse guides.
- For a perfect adhesion clean the tile and the suckers with a damp sponge.
- The suckers run along the guides and adhere to the tile. Make sure that a vacuum is created between the device and the surface.
- A single guide device can be used for sizes of maximum length.
- Use four operators at a time to carry out handling operations of large size format tiles.
- Lift the tile along the long side and hang it vertically to the handles of the frame.
- For the large size tile a suitably reinforced trolley is recommended. Set the guides to the trolley for carrying the tile.
- Follow the same procedure for handling the 120x280cm and all other sub-sizes, where only two operators are sufficient.

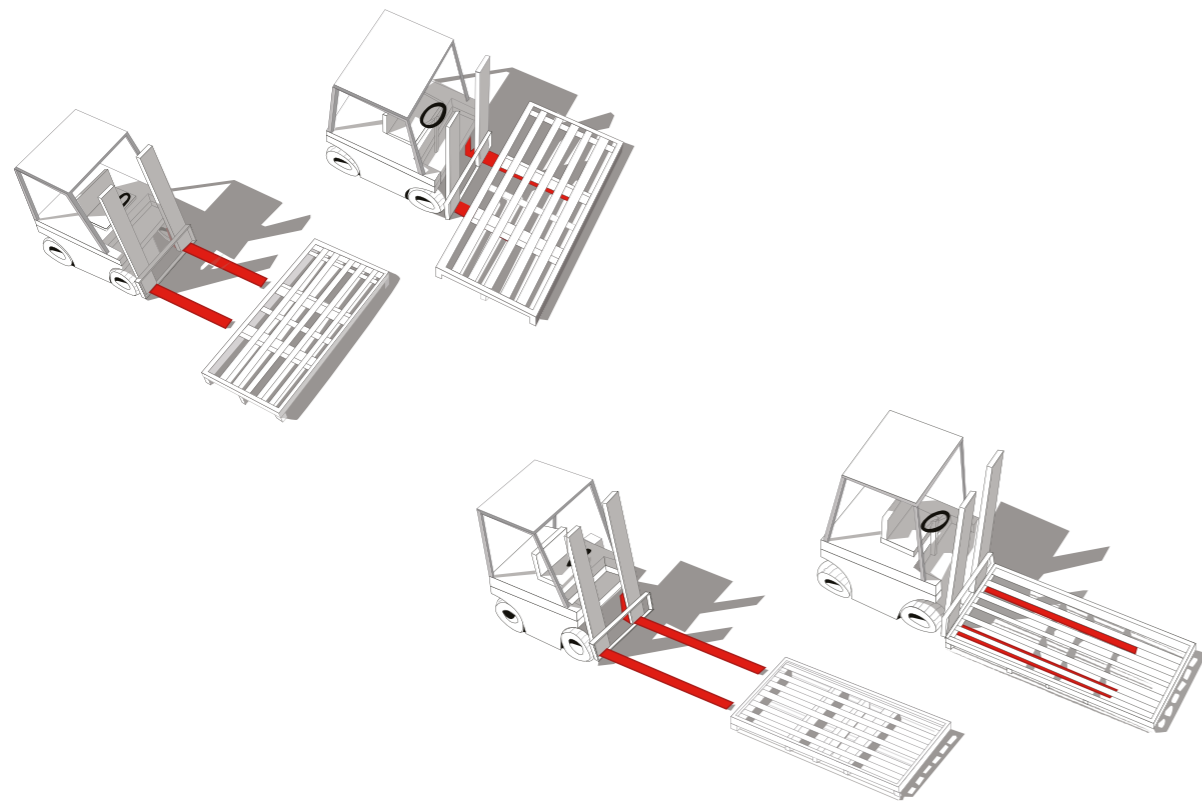
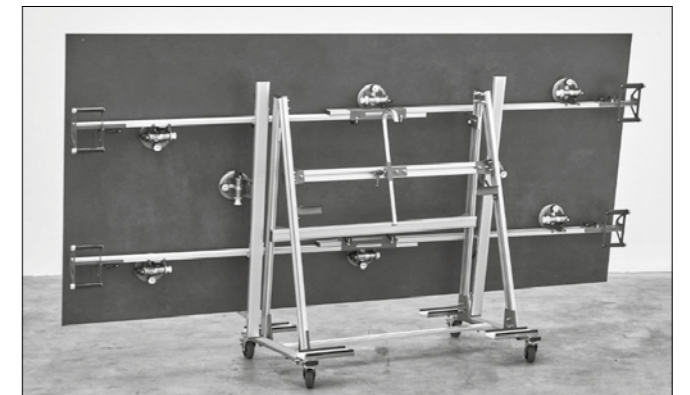
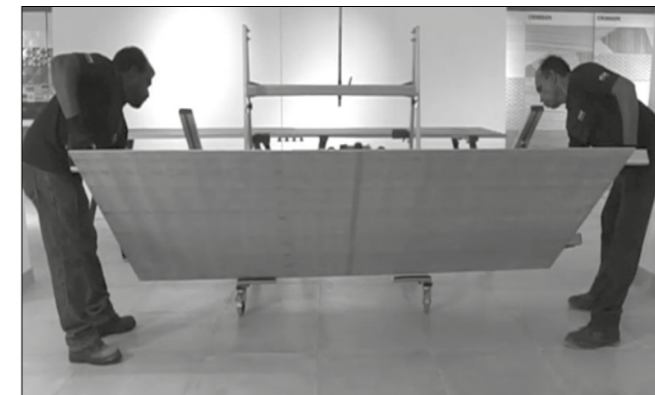
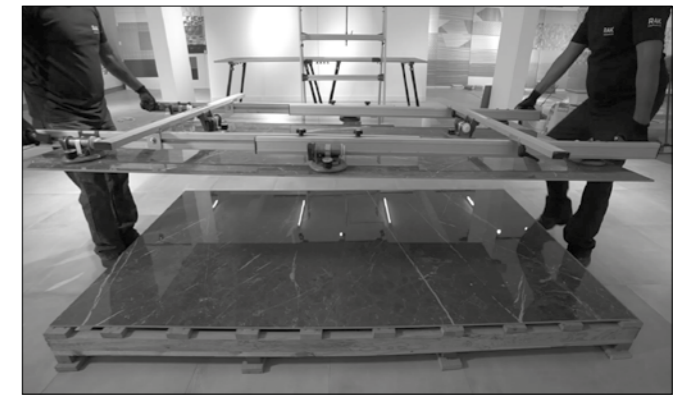
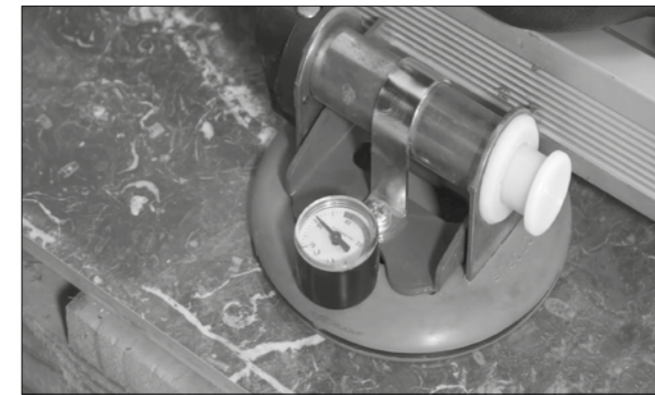
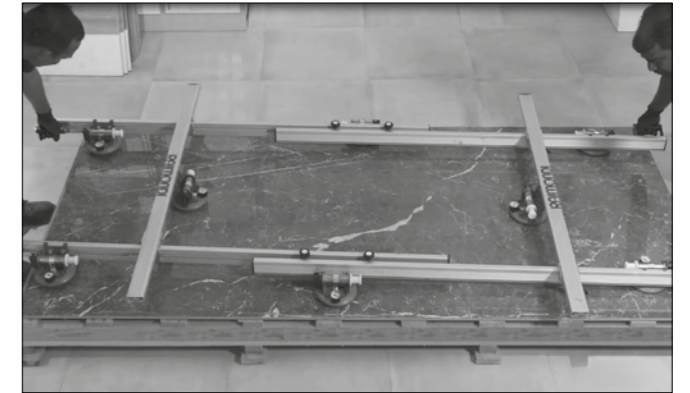
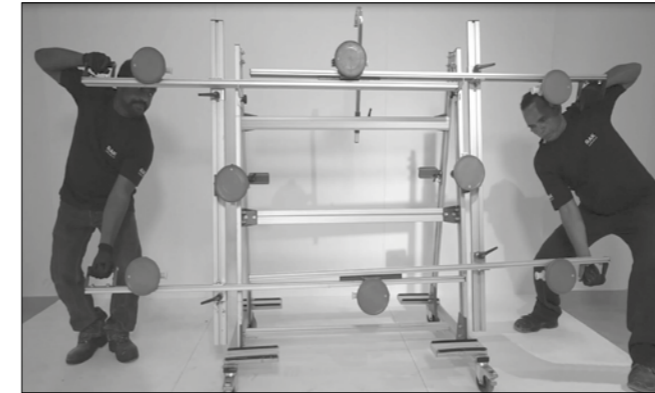

CUT-TO-PIECES AND DRILLING

- We recommend the use of special designed devices for handling as well as cutting and laying of large format tiles.
- Handle tile with a proper and professional trolley of aluminum parallel profile with crossbars and vacuum suction cups along with a vacuum gauge. Please use double suction cups for tiles above 300cm. This could make sure that appropriate vacuum is created between the device and the tile. Lift the tile and keep it vertically to the trolley frame.
- Keep the tile on a stable, flat and intractable surface. For successful cutting and drilling, we recommend using a professional modular workbench with aluminum profiles and proper cutting tools for each type of cut.
- Set the cutting unit on the tile so that the references coincide with the marked lines and lock it with the appropriate suckers. Score the tile from one edge to the other, being carefully maintaining the same pressure while moving.
- When the cut has been made, move the tile until the slit line sticks out a 10 to 15 cm from the workbench. Start hew from both sides using appropriate cutting-off pliers and follow the scoring line to complete the hew.
- Smooth rough edges and sides with an appropriate diamond polishing pad.
- To drill internal cutouts from the tile, first you need to draw the guide lines. For circular cuts, use the compass device with suction cups. For rectangular cut, drill first a 5 – 7 mm hole at the corners of the rectangle shape, using a non-percussion drill. For a better drilling always, keep the surface and drill a little bit wet. Then Follow the drilled lines using a diamond-blade angle grinder and then finish off the edges with a diamond-polishing pad. Round holes (4) must be made in wet drilling, using diamond-blades. Start engraving the surface with a 75 degrees point angle, then straighten out the drill avoiding excessive pressure on the tile. Also, in this case finish with a diamond-polishing pad.
- Manual traction devices are available, in order to make a finishing cut at 45° and thus enable special applications of the material.

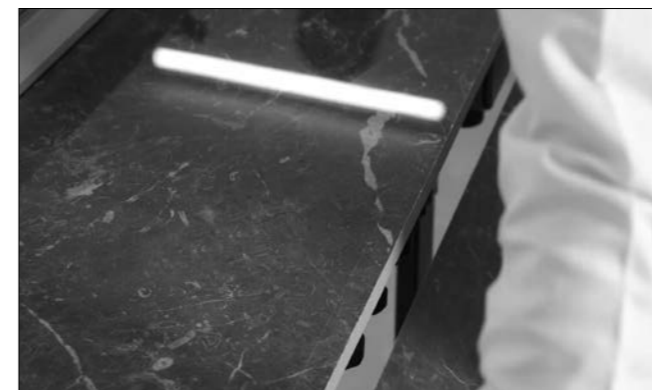
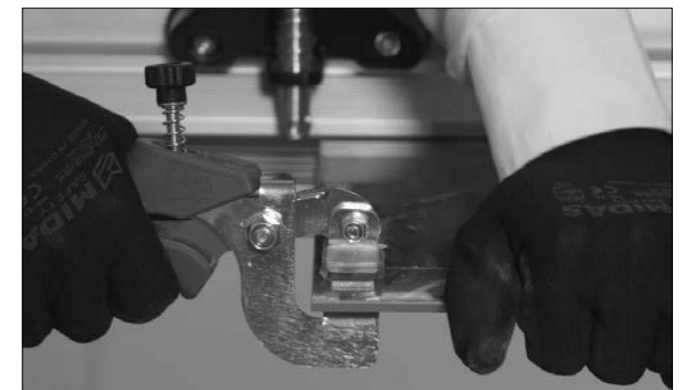
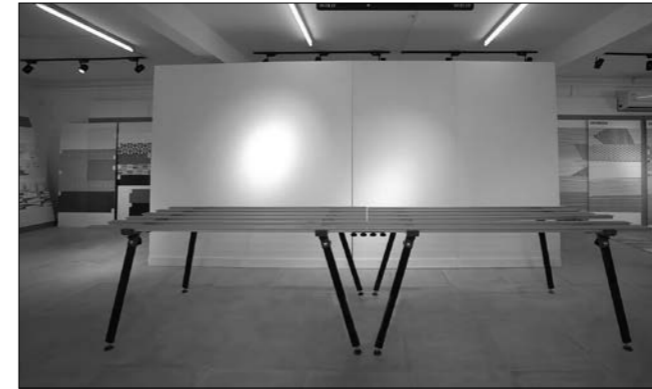

It is important to trim off, longitudinally and transversally the tile before any process. The distance for the cut to the edges must be proportional to the thickness of the tile.

The cutting direction must be always the same of the diamond disc rotation direction.

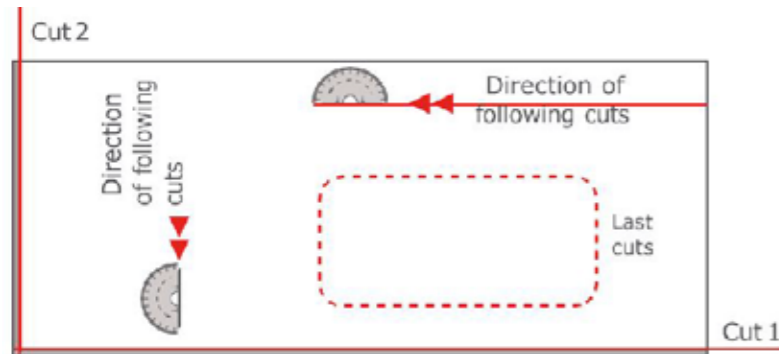

GENERAL INSTRUCTIONS FOR BRIDGE SAW WITH DIAMOND CUTTING DISC:



(pic.1)

*Be sure that the working table of the milling machine is flat.

*Use plenty of water while cutting. The jet of the water must be directed in front or at the side of the diamond disc, as much as possible close to the cutting area. (See pic.1).

GENERAL INSTRUCTIONS FOR BRIDGE SAW WITH DIAMOND CUTTING DISC:

Ø diamond cutting disc (mm)	RPM
Ø300	2800
Ø350	2400
Ø400	1600
Ø450	1400
Ø500	1260

*If the spindle speed is fixed, you must choose the diamond disc that requires a speed as close as possible to that spindle.

DIAMOND CUTTING DISC PARAMETERS OF BRIDGE SAW:

Type of cut	Feed rate mm/min thickness from 10 to 14.5mm	Feed rate mm/min thickness from 15 to 20mm
Cut entering from above the tile	100	100
Straight cut speed	1000	600
Inclined 45 ° cut speed	600	350

*For the first and the last 150mm it is advisable to reduce the feed rate by 50% (see Pic.2)

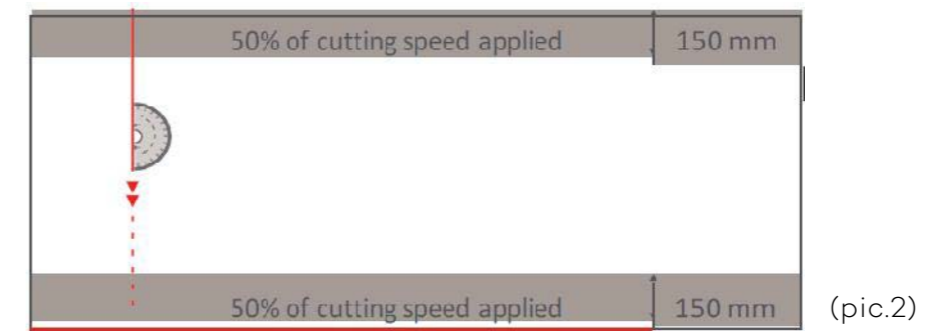

(pic.2)

EXAMPLE OF CUTTING DIAGRAM USING BRIDGE SAW WITH CUTTING DIAMOND DISC:

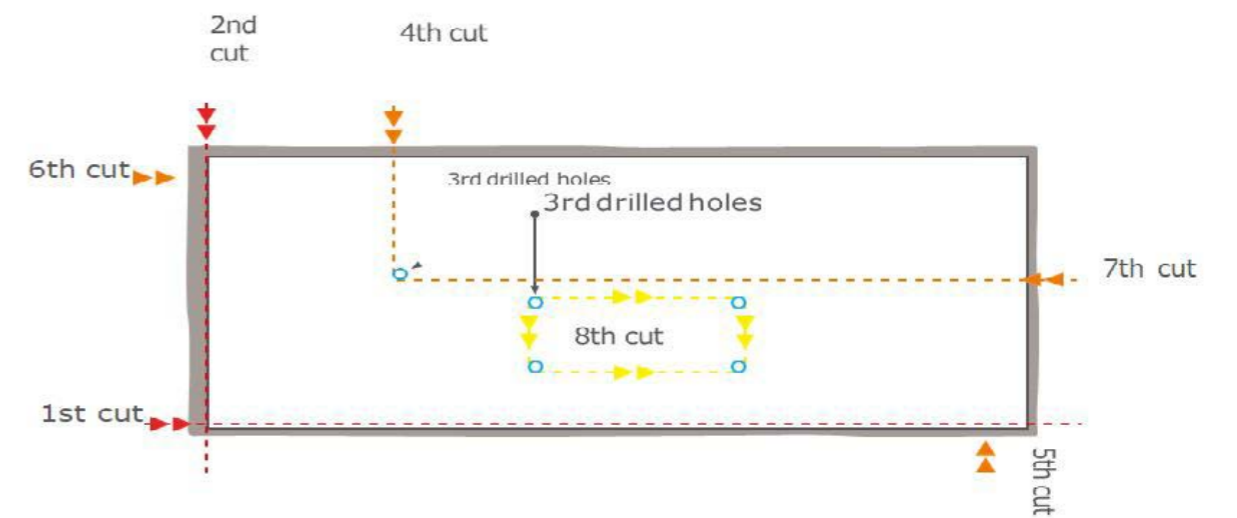

- 1- Tile trimming (red sections)
- 2- Core drilling (blu sections)
- 3- Top perimeter cutting (orange sections)
- 4- Interrupted cuts (yellow section)

EXAMPLE OF CUTTING DIAGRAM FOR SINK USING BRIDGE SAW WITH CUTTING DIAMOND DISC:

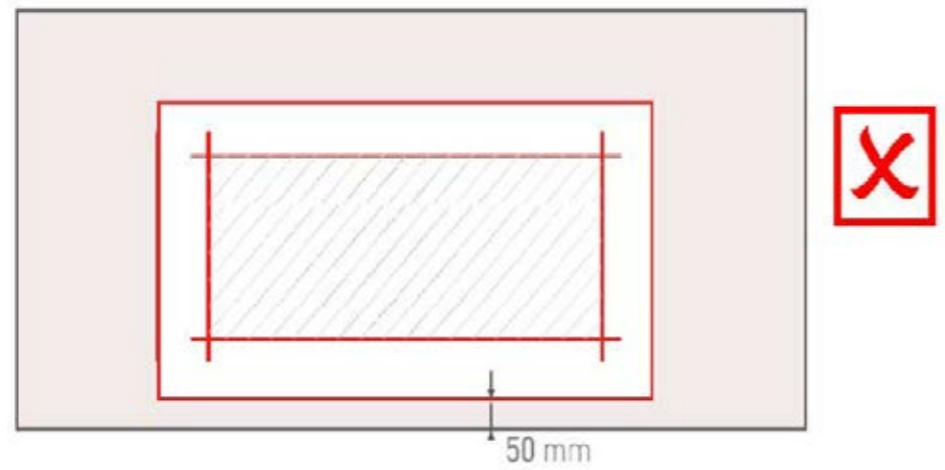
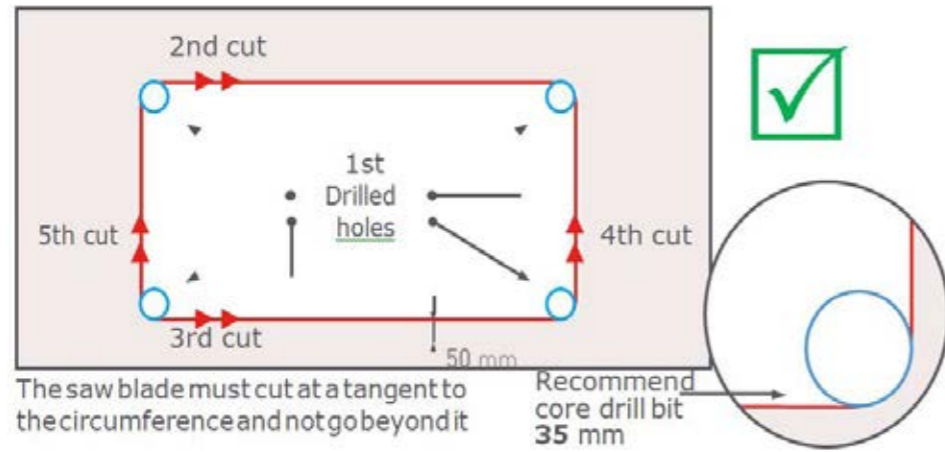

We recommend the below cutting diagram in case of one or more of the following conditions:

- non-flat resting base
- island not measuring more than 2600x600 mm
- sink not measuring more than 560x480 mm

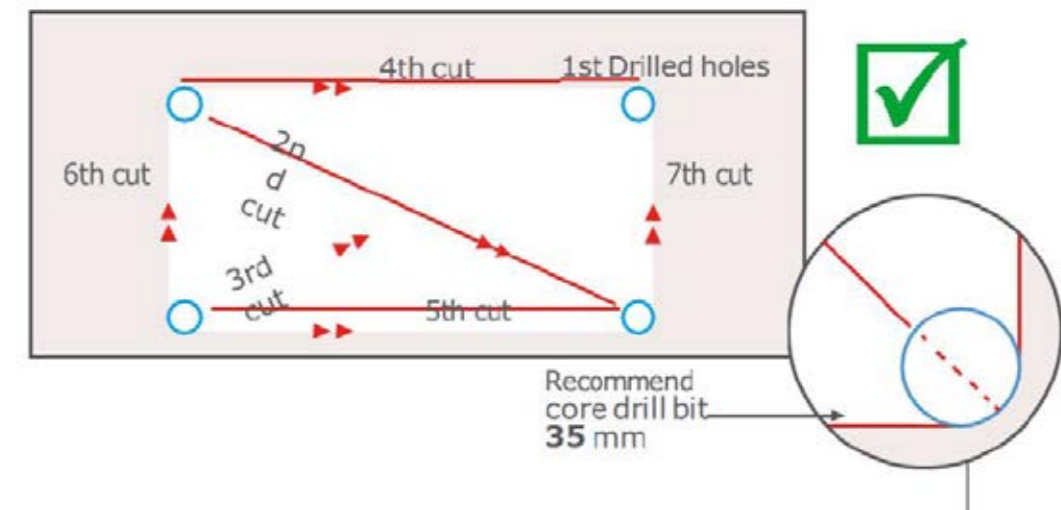

CUTTING DIAGRAM BY USING WATERJET MACHINE:

To cut the top outline, the profile should be divided into two parts and the first cut should be at the outer side of the tile. The outline cut must always be made after the trimming cuts.

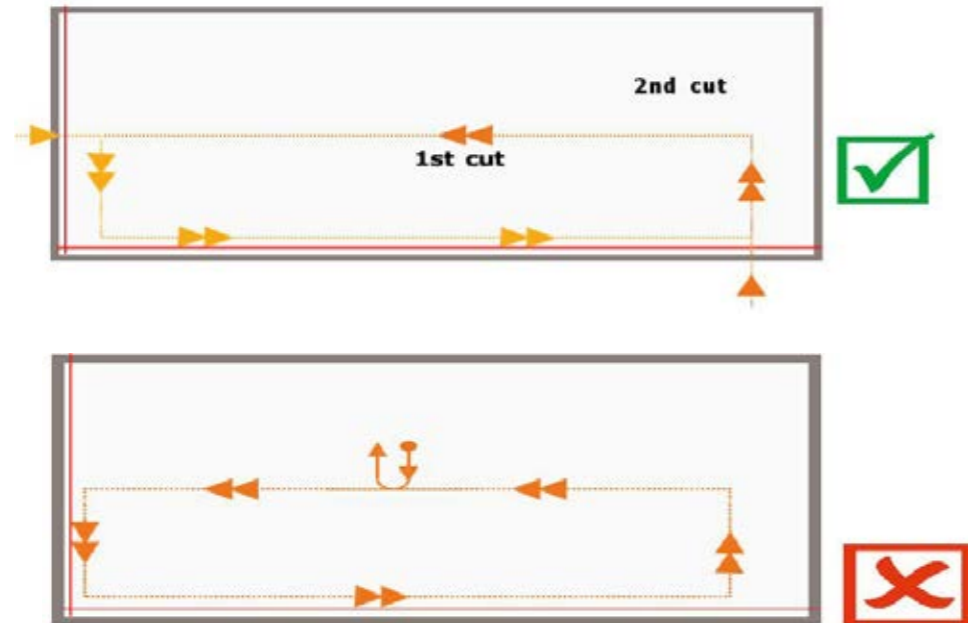

We recommend the below cutting diagram in case of one or more of the following conditions:

- non-flat resting base
- islands not measuring more than 2600x600 mm
- sinks not measuring more than 560x480 mm

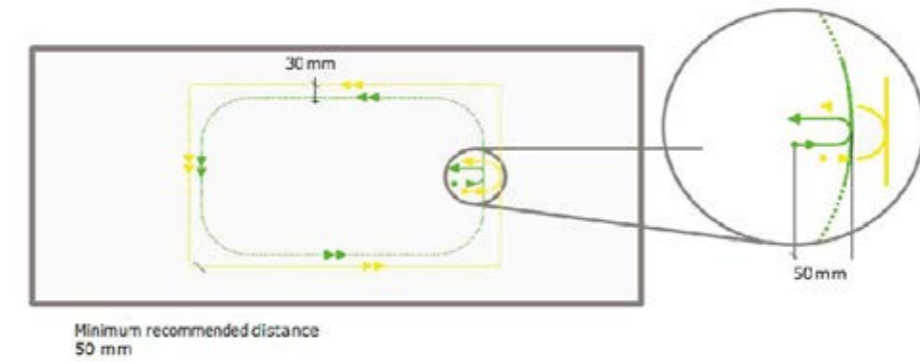

We recommend the below cutting in case of one or more of the following installation.

- 1- not flat resting base
- 2- island measuring more than 2600x600 mm
- 3- sink measuring more than 560x580 mm

EXAMPLE OF CUTTING DIAGRAM FOR SINK USING WATERJET MACHINE:

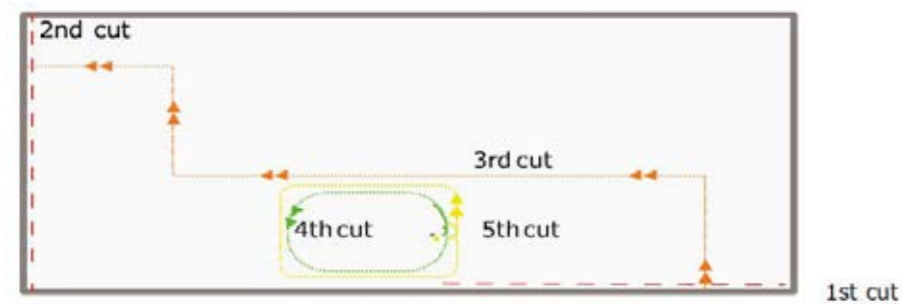

- 1-2 Tile trimming (red sections)
- 2- Workpiece shape cutting (orange sections)
- 3- Sink pre-cutting "if required" (green sections)
- 4- Sink cutting (yellow section)

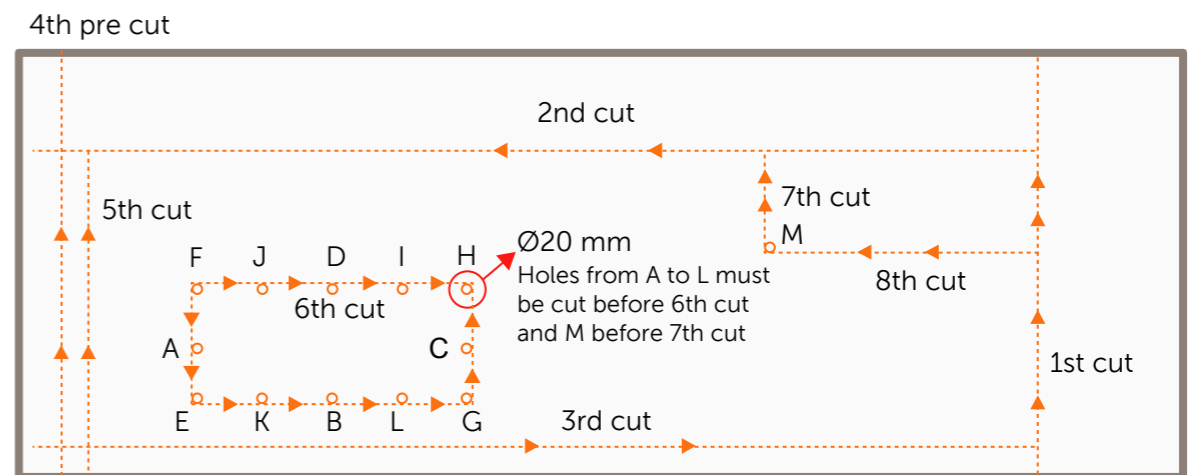

MINIMUM DISTANCE BETWEEN EDGE AND SINK HOLE:

The minimum distance recommended between the sink hole and the outer edge is 50mm

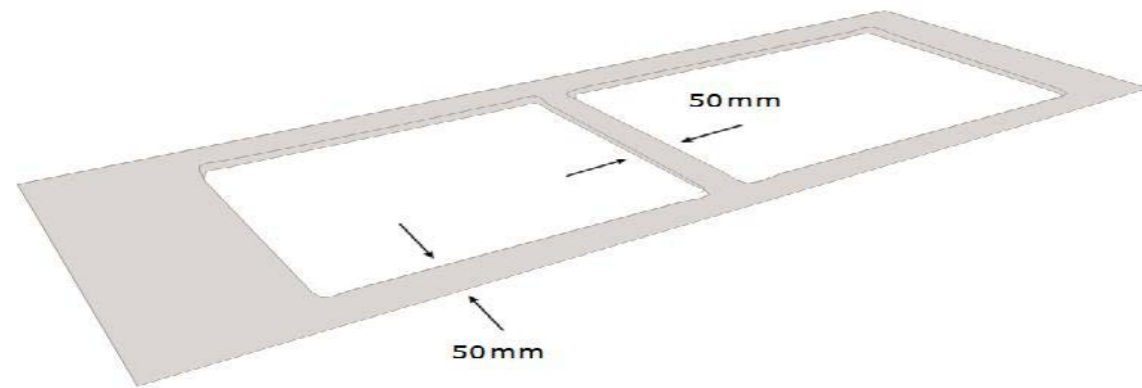

DESIGN OF HOLES FOR SINK. GAS/INDUCTION HOB:

To restrict the potential for breakage during handling and installation it is advisable to leave a strip of material in place to support the top. The top part (already cut half way through its thickness) should be completely cut off once the installation procedures are completed.

Large size hole:

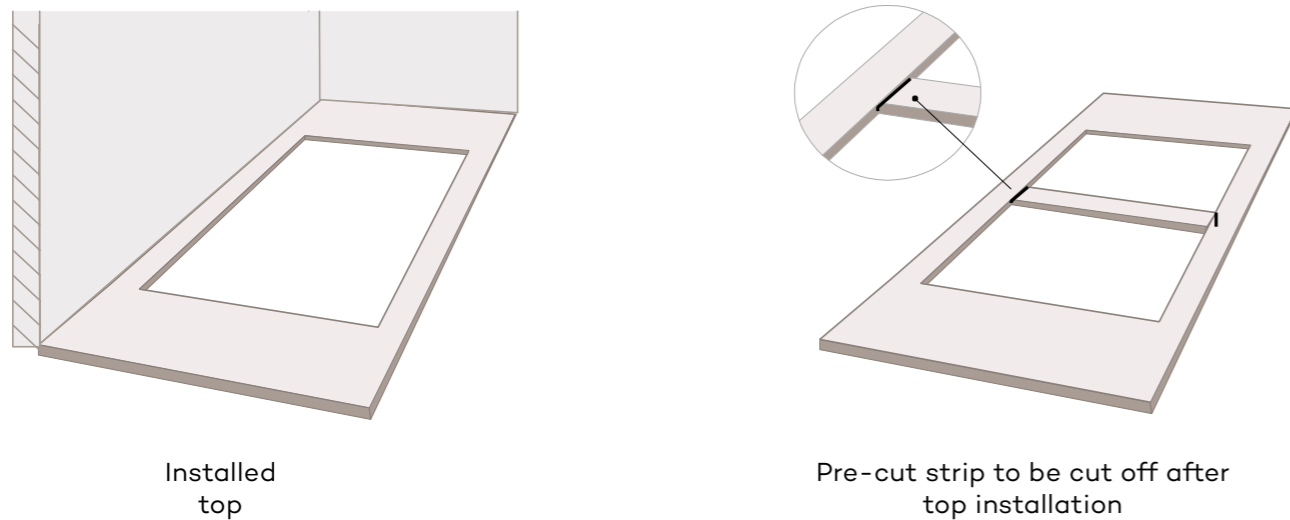

Interrupted sink hole:

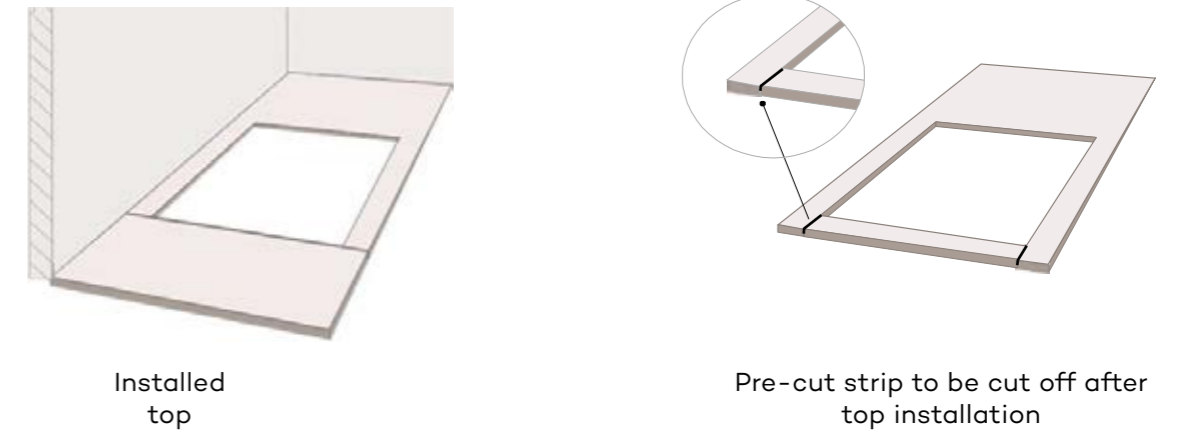

WATERJET PARAMETERS:

Low pressure piercing

High Pressure cutting parameter:

Thickness	Pressure (bar)	Abrasive 80 mesh Kg/min	Thickness	Minimum Pressure (bar)	Feed rate mm/min	Abrasive 80 mesh Kg/min
10 to 14.5	500 to 600	0.35-0.45	10 to 14.5	2200	200-300	0.35-0.45
15 to 20	600 to 700	0.35-0.45	15 to 20	2800	150-200	0.35-0.45

*The above data of Feed rate refers to the maximum recommended values. Reduce the feed speed rate to get a better finishing.

*In case of equal angles or angles smaller than 90° it is recommended to join up the corners with radius ≥ 5 mm.

RADIUSING:

We recommend that all internal angles follows at least a radius of 5mm. A greater radius imparts greater structural strength to the workpiece, while any Non-radiused corner will create a stress point on the top that causes breakages.



INSTALLATION

Laying "Maximus" requires similar laying conditions to those required for traditional format tiles. Maximus requires the adhesive to be applied both on the setting bed and on the back of the tile.

MAXIMUS FOR FLOORING REQUIRE THE FOLLOWING CONDITIONS:

- A flat surface that is clean and free from dust, scraps and any lumps of cement
- The setting bed must be uniform and have already undergone the dry shrinkage process
- Repair any cracks
- Any uneven parts on the surface must be filled with suitable levelling compounds

INSTRUMENTS REQUIRED

- Cement-based powder adhesive for full spread, class "C2E according to EN12004 and S1 according to EN12002 standards"
- 3x3 mm square toothed trowel and 15 mm round toothed trowel
- Frame with suction cups for handling or double suction cups
- Non-bounce plastic mallet 170x370 mm
- Levelling system: base clip + wedge + pliers

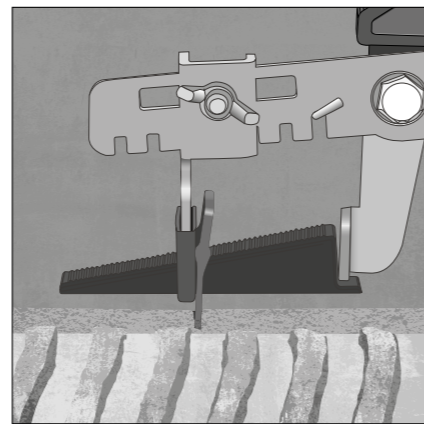
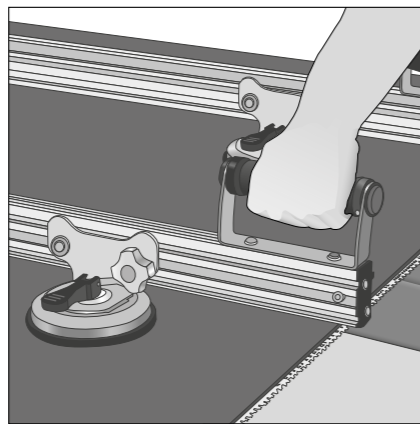
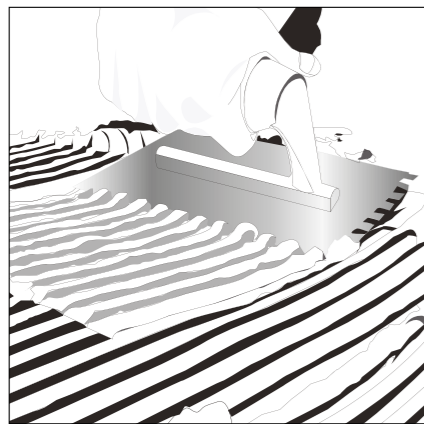

BONDING TO THE FLOOR

- Ensure that the surface to be covered is solid, flat and free from dust and oil/grease.
- Use the adhesives described above mixed according to the specifications indicated in the technical data sheet of the chosen adhesive.
- Spread the adhesive onto the surface to be covered with a 15 mm round toothed trowel across an area of 5/10 cm more than the dimensions of the tile.
- With the tile in a vertical position on the handling frame, spread the adhesive onto the back of the tile with a 3x3 mm square toothed trowel.
- Using the frame with suction cups, bring the tile into a horizontal position and lay it.
- To guarantee uniform bonding of the tile, the special 170x370 mm non-bounce plastic mallet must be used, tapping from the middle towards the edges so as to remove any air pockets between the back of the tile, the adhesive and the surface to be tiled using the levelling system.

BONDING TO THE WALL

- Ensure that the surface to be covered is solid, flat and free from dust.
- Cement-based powder adhesive for full spread, class "C2E according to EN12004 and S1 according to EN12002 standards".
- Spread the adhesive onto the surface to be covered with a 15 mm round toothed trowel across an area of 5/10 cm more than the dimensions of the tile.
- With the tile in a vertical position on the handling frame, spread the adhesive onto the back of the tile with a 3x3 mm square toothed trowel.
- Using the handling frame in a vertical position lay the tile.
- Before releasing the tile from the handling frame, ensure that the adhesive will hold it in place.
- To guarantee complete bonding of the tile and eliminate any air, tap from the middle towards the edges using the non-bounce plastic mallet.
- Before bonding the next tile, fix the hidden mechanical hook to the wall with the relevant nails (length 27 mm) using the gas-powered nailing machine.

VENTILATED FAÇADE

Maximus – Ventilated Façade Systems

A ventilated façade is a coating system on the outside of a building which leaves a ventilated chamber between the coating (façade) and the building insulation. Considered as the best solution for maximising insulation whilst reducing unwanted condensation or thermal bridge problems, ventilated façades provide excellent thermal-hygrometric solutions.

- Advantages of Ventilated Façade Systems
- Energy Saving – Excellent thermal insulation, reduction in heat/cool dispersal, and less heat absorption in warm climates.
- Technical and Aesthetic Durability – Significant reduction in deterioration due to pollution, does not absorb dust or dirt, easy to clean and maintain and promotes humidity dispersal.
- Healthier Environment – Increased comfort for users and meets all hygiene, health and environmental protection standards.



GROUT FILLING

- Use a professional and high quality grouting products.
- While stirring, pour the grout into a clean and rust free container, containing 22/26 percent by weight of clean water.
- Mix the grout with a low-speed mixer to avoid air entrapment, until a smooth paste is obtained.
- Let the mix stand for 2-3 minutes. Stir again briefly before use.
- Use the mixture within 20-25 minutes of its preparation.
- Fill the joints with a special grout float or rubber squeeze without leaving any gaps or steps. Remove any excess grout and leave for 15-30 minutes.
- Clean off the excess mixture with a hard, damp sponge, working in a diagonal direction to the joints.



CLEANING AND MAINTENANCE

Maximus products are non porous (due to their high quality raw materials, stringent production parameters and state of the art technology), hence any dust or deposited waste cannot penetrate the surface.

For most cases only a damp cloth is sufficient for cleaning.

Regular cleaning highlights the aesthetic features of the surface and gives it exceptional shine.

For highly aggressive cleaning caused by some common food and substances follow the table below.

TYPE OF STAIN	CHEMICAL PRODUCT	EXAMPLE
Grease	Alkaline - Solvent	Detergent
Oil	Solvent	Ammonia
Ink	Oxidant - Solvent	Alcohol
Rust	Acid	Hydrolic acid
Lime	Acid	Descaling products
Cement	Acid	Hydrolic acid
Wine	Alkaline	Ammonia or Bleach
Coffee	Alkaline - Solvent	Ammonia or Bleach
Rubber	Solvent	Alcohol
Plaster	Acid	Hydrolic acid
Candle wax	Solvent	Alcohol
Iodine	Oxidant	Bleach
Blood	Oxidant	Bleach
Ice cream	Alkaline	Detergent
Resins	Solvent	Alcohol
Fruit juices	Oxidant	Bleach

Disclaimer: The aim of this manual is to offer helpful suggestions about handling and maintaining Maximus tiles. Due to nature of sintered ceramic material, it is highly advisable to consult an expert for these purposes. RAK Ceramics cannot be held responsible for any damage resulting from using the information and suggestions contained in this technical manual.

NOTES

MAXIMUSSURFACES.COM



MAXIMUSSURFACES.COM